

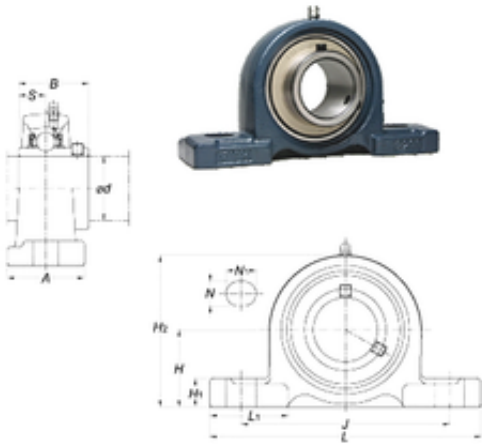

FYH UCP215-48 bearing units



Bearing No. UCP215-48

Bore Diameter	76,2 mm
Width	77,8 mm
d	76,2 mm
A	74 mm
B	77,8 mm
H	82,6 mm
H1	28 mm
H2	162 mm
J	217 mm
L	275 mm
L1	80 mm
N	25 mm
N1	30 mm
S	33,3 mm
Bolt (G)	M20
Weight	7,4 Kg
Basic dynamic load rating (C)	67,4 kN
Basic static load rating (C0)	48,3 kN

UCP215-48 Bearing 2D drawings and 3D CAD models