

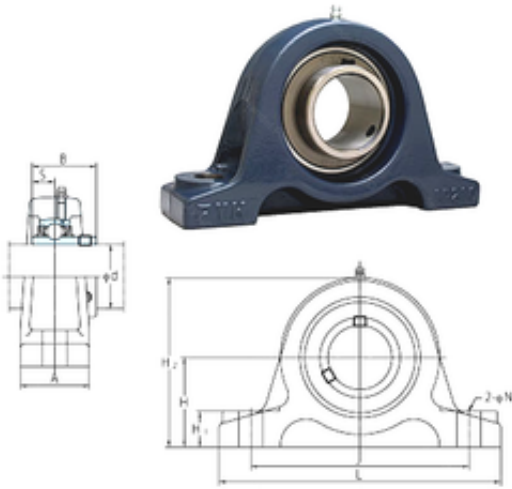

FYH UCIP212-38 bearing units

Bearing No. UCIP212-38



UCIP212-38 Bearing 2D drawings and 3D CAD models

Bore Diameter	60,325 mm
Width	65,1 mm
d	60,325 mm
A	70 mm
B	65,1 mm
H	80 mm
H1	30 mm
H2	155 mm
J	200 mm
L	260 mm
N	22 mm
S	25,4 mm
Bolt (G)	M20
Weight	7,2 Kg
Basic dynamic load rating (C)	52,4 kN
Basic static load rating (C0)	36,2 kN